

Type-C Port Controller Evaluation Board

General Description

The RT1718SGQW is a USB Type-C controller that complies with the latest USB Type-C and PD standards. This document explains the function and use of the RT1718SGQW evaluation board (EVB), and provides information to enable operation, modification of the evaluation board and circuit to suit individual requirements.

Table of Contents

General Description	1
Performance Specification Summary	2
Operations	2
Detailed Description of Hardware	4
Bill of Materials.....	7
Typical Applications	12
More Information.....	21
Important Notice for Richtek Evaluation Board.....	21

Performance Specification Summary

The RT1718SGQW is a USB Type-C controller that complies with the latest USB Type-C and PD standards. The RT1718SGQW integrates a complete Type-C Transceiver including the Rp and Rd resistors. It does the USB Type-C detection including attach and orientation. The RT1718SGQW integrates the physical layer of the USB BMC power delivery protocol to allow up to 90W of power and role swap.

Table 1. RT1718SGQW Evaluation Board Performance Specification Summary

Key Features	Evaluation Board Number: PCB123_V1
Default Input Voltage	45W PD TA or higher at USB2 (Type-C connector, "Adapter")
VBUS Output Current	5A at UAB1 or U411
VBUS Voltage	5V to 20V at UAB1 or U411
Default Marking & Package Type	RT1718SGQW, WQFN-32L 4x4 (W-Type)
Operation Mode	Normal Mode: DRP, Dead battery. Meter Mode

Operations

The RT1718SGQW EVB supports two modes. The one is normal mode (hardware default) where USB1 and U411 are DRP when there is PD TA (45W or higher) at USB2, or USB1 and U411 are dead battery when there is no PD TA (45W or higher) at USB2. The PD power at USB1 or U411 will be less than the power of PD TA at USB2 by 10W. Please do not connect to two devices at USB1 and U411 under normal mode operation. The other one is meter mode where the VBUS voltage and VBUS current (the current direction from U411 to USB1 is positive) of two PD devices at USB1 and U411 are reported on Display. In meter mode, PD TA at USB2 is not necessary.

The following table shows the settings for normal mode and meter mode.

Mode	CP3	CP4	CP13	CP14
Normal Mode (Default)	Short	Short	Open	Open
Meter Mode	Open	Open	Short	Short

By pressing SW1, MCU will be reset.

SW2, SW4, SW5, and SW3 work only under normal mode.

Button	Function	Behavior
SW2	Request Previous PDO	RT1718SGQW as sink will request the previous PDO in Source PDO order by pressing this button.
SW4	Vconn Swap	RT1718SGQW will send Vconn Swap message to port partner.
SW5	Request Next PDO	RT1718SGQW as sink will request the next PDO in Source PDO order by pressing this button.
SW3	Power Role Swap	RT1718SGQW will send Power Role Swap message to port partner. If there is no PD adapter at USB2 (45W or higher), there will be no action by pressing this button.

The display shows the information according to the setting and attachment as the following table. By each pressing SW6, the information will be shown in sequence.

Mode	USB2	USB1 or U411	Display information in sequence.
Normal Mode	No TA	No Attached	NA
Normal Mode	No TA	Attached	<ol style="list-style-type: none"> 1. Power Role, Vconn on/off 2. PD Contract 3. Vbus Status (real vbus voltage and current) 4. Remote SRC Cap 5. Remote SNK Cap
Normal Mode	TA	No Attached	<ol style="list-style-type: none"> 1. DRP, Unattach 2. TA Power. Vbus voltage, current (Contract)
Normal Mode	TA	Attached	<ol style="list-style-type: none"> 1. Power Role, Vconn on/off 2. PD Contract 3. Vbus Status (real vbus voltage and current) 4. Remote SRC Cap 5. Remote SNK Cap 6. Cable Info (if there is e-mark IC in cable.) 7. TA Power. Vbus voltage, current (Contract)
Meter Mode	Don not care	Two devices attached at USB1 and U411.	Real Vbus voltage, current

LED2 will light up if the power of TA at USB2 is lower than 45W.

Detailed Description of Hardware

Headers Description and Placement

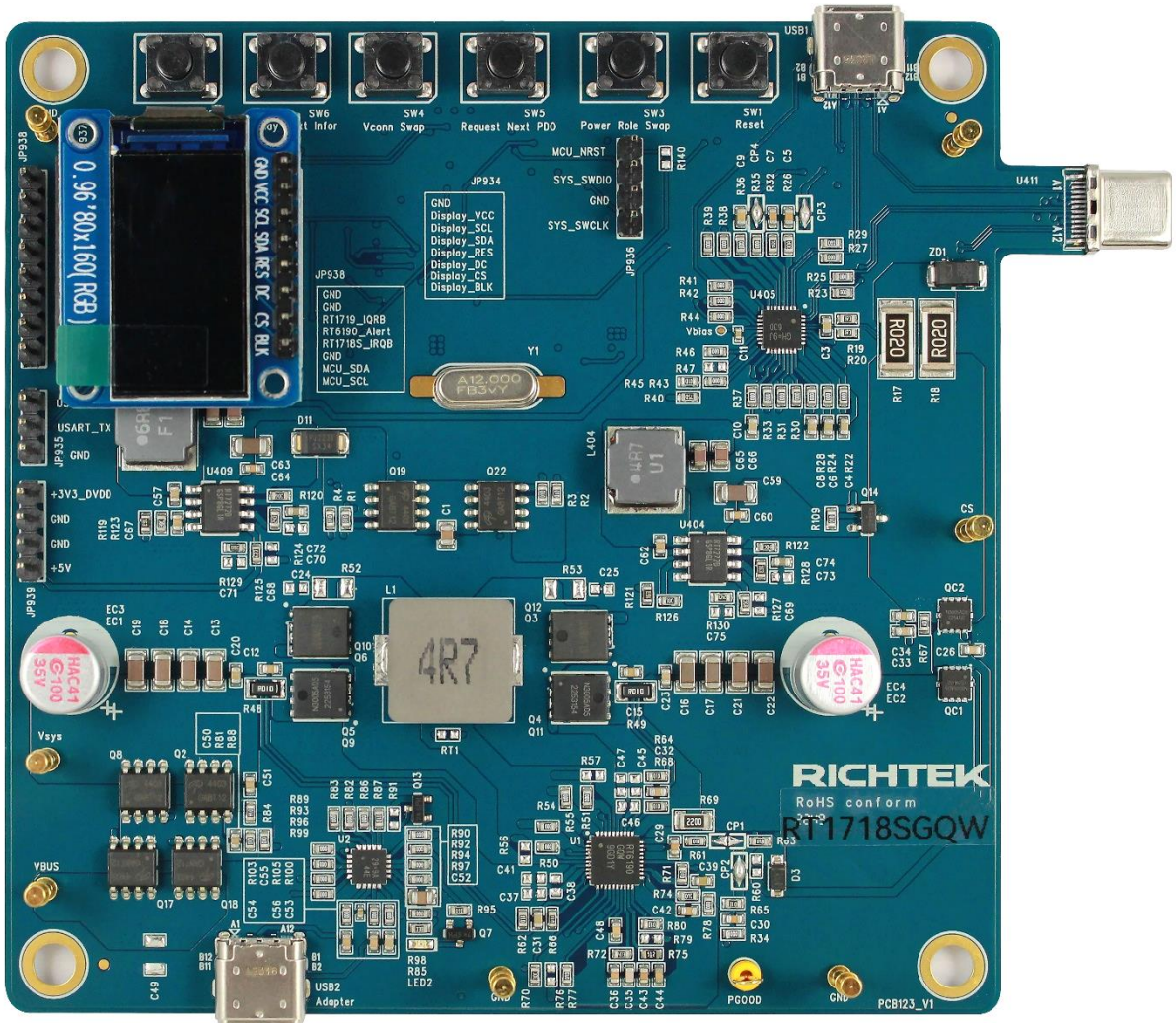

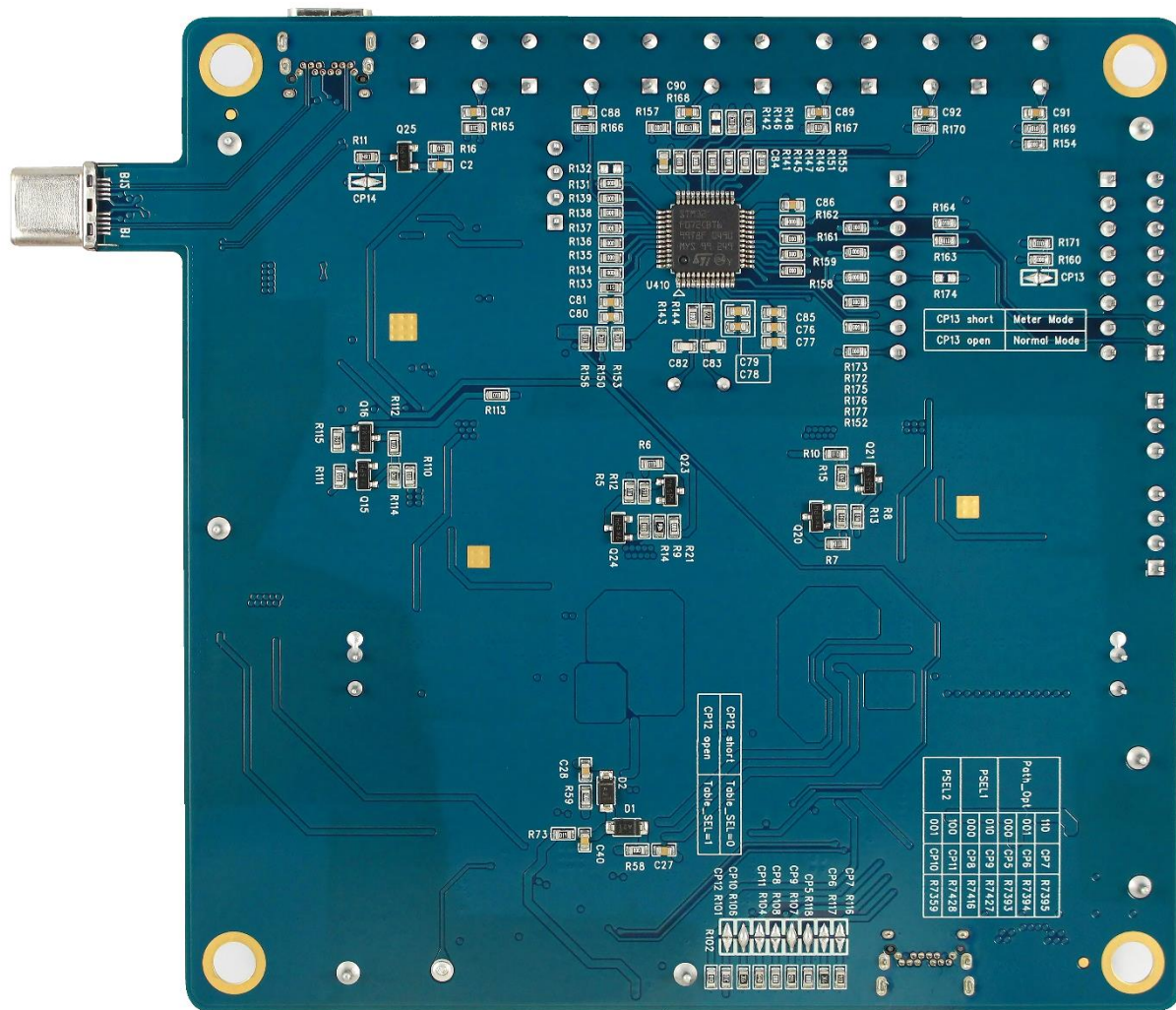

Carefully inspect all the components used in the EVB according to the following Bill of Materials table, and then make sure all the components are undamaged and correctly installed. If there is any missing or damaged component, which may occur during transportation, please contact our distributors or e-mail us at evb_service@richtek.com.

Test Points

The EVB is provided with the test points and pin names listed in the table below.

Test Point/ Pin Name	Signal	Comment (expected waveforms or voltage levels on test points)
VBUS	Voltage	The VBUS of “Adapter” USB2.
Vsys	Voltage	The system voltage
CS	Voltage	The VBUS of Connector U411
GND	Ground	Ground
+5V	Voltage	The 5V voltage source on board and also the Vconn power of RT1718SGQW.
+3V3_DVDD	Voltage	The 3.3V voltage source on board and also the power of RT1718SGQW and MCU.

Test Point/ Pin Name	Signal	Comment (expected waveforms or voltage levels on test points)
UART_TX /UART_RX	Signal for log	These two pins are used to trace log of MCU.
MCU_SDA /MCU_SCL	I2C Signal	These two pins are I ² C communication between RT1718SGQW, RT1719GQW, RT6190GQW and MCU.
RT1718SGQW_IRQB	Interrupt of RT1718SGQW	This pin is used to inform MCU by RT1718SGQW.
RT6190GQW_IRQB	Interrupt of RT6190GQW	This pin is used to inform MCU by RT6190GQW.
RT1719GQW_IRQB	Interrupt of RT1719GQW	This pin is used to inform MCU by RT1719GQW.
MCU_NRST	Reset of MCU	This pin is used to reset MCU.
SYS_SWDIO /SYS_SWCLK	Signal for programming	These two pins are used to programming MCU.

Bill of Materials

Reference	Count	Part Number	Value	Description	Package	Manufacturer
C1, C52	2	UMK212B7105KG-T	1 μ F	50V/X7R	0805	TAIYO YUDEN
C2, C44	2	0603B103K500CT	10nF	50V/X7R	0603	WALSIN
C3, C4, C6, C8, C9, C10, C20, C23, C26, C31, C32, C33, C34, C53, C80, C84, C93	17	0603X105K250CT	1 μ F	25V/X5R	0603	WALSIN
C5, C7	2	0603B561K500CT	560pF	50V/X7R	0603	WALSIN
C11, C55	2	0402B104K500CT	0.1 μ F	50V/X7R	0402	WALSIN
C12, C15, C27, C28, C42, C50, C51, C57, C62, C67, C76, C77, C78, C79, C81, C85, C86, C87	18	GRM188R71H104KA93D	0.1 μ F	50V/X7R	0603	MURATA
C13, C14, C16, C17, C18, C19, C21, C22	8	TMK316AB7106KL-T	10 μ F	25V/X7R	1206	TAIYO YUDEN
C29	1	0603B152K500CT	1.5nF	50V/X7R	0603	WALSIN
C30, C60, C64, C94	4	0603B102K500CT	1nF	50V/X7R	0603	WALSIN
C35	1	0603N1R0C500CT	1pF	50V/NPO	0603	WALSIN
C36	1	0603B332K500CT	3.3nF	50V/X7R	0603	WALSIN
C39, C40	2	0603X225K160CT	2.2 μ F	16V/X5R	0603	WALSIN
C43	1	0603N221J500CT	220pF	50V/NPO	0603	WALSIN
C48	1	0603B333K500CT	33nF	50V/X7R	0603	WALSIN
C54, C56	2	0603B471K500CT	470pF	50V/X7R	0603	WALSIN
C58, C61, C65, C66	4	0805X226M250CT	22 μ F	25V/X5R	0805	WALSIN
C59, C63	2	GRM31CR71H475KA12L	4.7 μ F	50V/X7R	1206	MURATA
C72, C74	2	0603B272K500CT	2.7nF	50V/X7R	0603	WALSIN
C82, C83	2	0603N180J500CT	18pF	50V/NPO	0603	WALSIN
C88, C89, C90, C91, C92	5	0603B473K250CT	47nF	25V/X7R	0603	WALSIN
D1, D2, D3	3	1N4148W	1N4148W	1N4148W	SOD-123	PANJIT

Reference	Count	Part Number	Value	Description	Package	Manufacturer
D11	1	SX34	SX34	SX34	SMA/DO-214AC	PANJIT
EC3, EC4	2	350ARHA101M08X8	100µF/35V	35V/Aluminum	RADIAL	APAQ
L1	1	M13A4R7B8MR	4.7µH	15A	L-13-5X12-8	NICHTEK
L404	1	NR8040T4R7N	4.7µH	4.1A	L-8x8	TAIYO YUDEN
L406	1	NRS8040T6R8NJGJ	6.8µH	3.7A	L-8x8	TAIYO YUDEN
LED2	1	LNL-191SUR	RED	LED_RED-0603	0603	LighTop
Q2, Q8, Q17, Q18, Q19, Q22	6	AO4403	AO4403	AO4403	SOIC-8	Alpha & Omega
Q3, Q10	2	MSYG150N03A-N	MSYG150N03A-N	MSYG150N03A-N	PDFN5x6_8L	NICHTEK
Q4, Q9	2	MSLN3005AD5-N	MSLN3005AD5-N	MSLN3005AD5-N	DFN5x6_8L	NICHTEK
Q5, Q11	2	SM3439NHQA	SM3439NHQA	SM3439NHQA	DFN3.3x3.3A-8_EP	SINOPOWER
Q6, Q12	2	SM3433NHQG	SM3433NHQG	SM3433NHQG	MOS_DFN3-3B-8_EP	SINOPOWER
Q7, Q13	2	2N7002K-T1-GE3	2N7002K-T1-GE3	2N7002K-T1-GE3	SOT-23	VISHAY
Q14	1	AO3403	AO3403	AO3403	SOT-23-3L	Alpha & Omega
Q15, Q16, Q20, Q21, Q23, Q24, Q25	7	2N7002K	2N7002K	2N7002K	SOT-23	PANJIT
QC1, QC2	2	MSLN3005AD3-N	MSLN3005AD3-N	MSLN3005AD3-N	PDFN3.3x3.3_8L	NICHTEK
R1, R2, R3, R4, R6, R7, R10, R45, R71, R77, R80, R81, R87, R88, R102, R109, R110, R111, R113, R171	20	WR06X1003FTL	100k	Resistor, Chip, 1/10W, 1%	0603	WALSIN
R5, R8, R84, R112	4	WR06X1000FTL	100	Resistor, Chip, 1/10W, 1%	0603	WALSIN
R9	1	RTT032943FTP	294k	Resistor, Chip, 1/10W, 1%	0603	RALEC
R11	1	WR06W4R30FTL	4.3	Resistor, Chip, 1/10W, 1%	0603	WALSIN
R12, R13, R15, R114, R115	5	WR06X4023FTL	402k	Resistor, Chip, 1/10W, 1%	0603	WALSIN

Reference	Count	Part Number	Value	Description	Package	Manufacturer
R14	1	WR06X8063FTL	806k	Resistor, Chip, 1/10W, 1%	0603	WALSIN
R16, R74, R101, R146, R148, R150, R153, R156, R165	9	WR06X1002FTL	10k	Resistor, Chip, 1/10W, 1%	0603	WALSIN
R17, R18	2	RTT25R020FTE	0.02	Resistor, Chip, 1/1W, 1%	2512	RALEC
R19, R20	2	WR06W3R30FTL	3.3	Resistor, Chip, 1/10W, 1%	0603	WALSIN
R21, R22, R23, R24, R25, R27, R28, R29, R30, R31, R33, R34, R35, R36, R37, R38, R39, R41, R42, R43, R44, R46, R50, R51, R54, R55, R58, R59, R78, R82, R83, R86, R89, R90, R92, R93, R94, R96, R97, R98, R99, R100, R103, R105, R108, R118, R131, R134, R135, R136, R137, R138, R139, R141, R143, R145, R147, R149, R151, R152, R154, R155, R157, R158, R159, R160, R161, R162, R172, R173, R175, R176, R177	73	WR06X000 PTL	0	Resistor, Chip, 1/10W, 1%	0603	WALSIN
R26, R32	2	WR06X2000FTL	200	Resistor, Chip, 1/10W, 1%	0603	WALSIN
R40	1	WR06X5903FTL	590k	Resistor, Chip, 1/10W, 1%	0603	WALSIN
R48, R49	2	RLM-1632-6F-R010- FNH	0.01	Resistor, Chip, 1/1W, 1%	1632	CYNTEC

Reference	Count	Part Number	Value	Description	Package	Manufacturer
R61, R63, R163, R164, R166, R167, R168, R169, R170	9	WR06X1001FTL	1k	Resistor, Chip, 1/10W, 1%	0603	WALSIN
R62, R64, R66, R68	4	WR06X10R0FTL	10	Resistor, Chip, 1/10W, 1%	0603	WALSIN
R65, R95	2	WR06X1004FTL	1M	Resistor, Chip, 1/10W, 1%	0603	WALSIN
R67	1	WR06W2R00FTL	2	Resistor, Chip, 1/10W, 1%	0603	WALSIN
R69	1	WR12X2200FTL	220	Resistor, Chip, 1/4W, 1%	1206	WALSIN
R70, R123, R126	3	RTT032002FTP	20k	Resistor, Chip, 1/10W, 1%	0603	RALEC
R72	1	WR06X4702FTL	47k	Resistor, Chip, 1/10W, 1%	0603	WALSIN
R73	1	WR06W1R00FTL	1	Resistor, Chip, 1/10W, 1%	0603	WALSIN
R75	1	WR06X5101FTL	5.1k	Resistor, Chip, 1/10W, 1%	0603	WALSIN
R85	1	WR06X2151FTL	2.15k	Resistor, Chip, 1/10W, 1%	0603	WALSIN
R104	1	WR06X4533FTL	453k	Resistor, Chip, 1/10W, 1%	0603	WALSIN
R106, R117	2	RTT035622FTP	56.2k	Resistor, Chip, 1/10W, 1%	0603	RALEC
R107	1	WR06X1433FTL	143k	Resistor, Chip, 1/10W, 1%	0603	WALSIN
R116	1	RTT038873FTP	887k	Resistor, Chip, 1/10W, 1%	0603	RALEC
R119, R121, R128	3	RTT031602FTP	16k	Resistor, Chip, 1/10W, 1%	0603	RALEC
R120, R122	2	WR06X8452FTL	84.5k	Resistor, Chip, 1/10W, 1%	0603	WALSIN
R124, R130	2	WR06X2402FTL	24k	Resistor, Chip, 1/10W, 1%	0603	WALSIN
R125	1	WR06X6202FTL	62k	Resistor, Chip, 1/10W, 1%	0603	WALSIN
R127	1	WR06X7502FTL	75k	Resistor, Chip, 1/10W, 1%	0603	WALSIN
R129	1	CR0603F11K8P05	11.8k	Resistor, Chip, 1/10W, 1%	0603	EVER OHMS
R133	1	WR06X5100FTL	510	Resistor, Chip, 1/10W, 1%	0603	WALSIN
R144	1	RTT032200FTP	220	Resistor, Chip, 1/10W, 1%	0603	RALEC
U1	1	RT6190GQW	RT6190GQW	Buck-Boost controller	WQFN-40L 5x5	RICHTEK

Reference	Count	Part Number	Value	Description	Package	Manufacturer
U2	1	RT1719GQW	RT1719GQW	Sink Only Type-C Port Controller	WQFN-20L 3.5x3.5	RICHTEK
U404, U409	2	RT7272BGSP	RT7272BGSP	Buck Converter	SOP-8 (Exposed Pad)	RICHTEK
U405	1	RT1718SGQW	RT1718SGQW	TCPC	WQFN-32L 4x4	RICHTEK
U410	1	STM32F072CBT6	STM32F072CB T6	MCU	LQFP7_ 48L	STM
U411	1	c-nbw31-00-00	Type-C PLUG	PLUG	8.95x9.25x 2.40mm	ACON
USB1	1	C-NBR2L-AK5320	Type-C Receptacle	Receptacle_ DRP	9.24x 9.1mm	ADVANCED- CONNECTEK
USB2	1	C-NBR2L-AK5320	Type-C Receptacle	Receptacle_ SinkOnly	9.24x 9.1mm	ADVANCED- CONNECTEK
Y1	1	49S-012000-FX4X17	12MHz	12MHz	HC-49US	AKER
ZD1	1	BZG05C27	BZG05C27	BZG05C27	SMA/DO- 214AC	VISHAY

Typical Applications

EVB Schematic Diagram

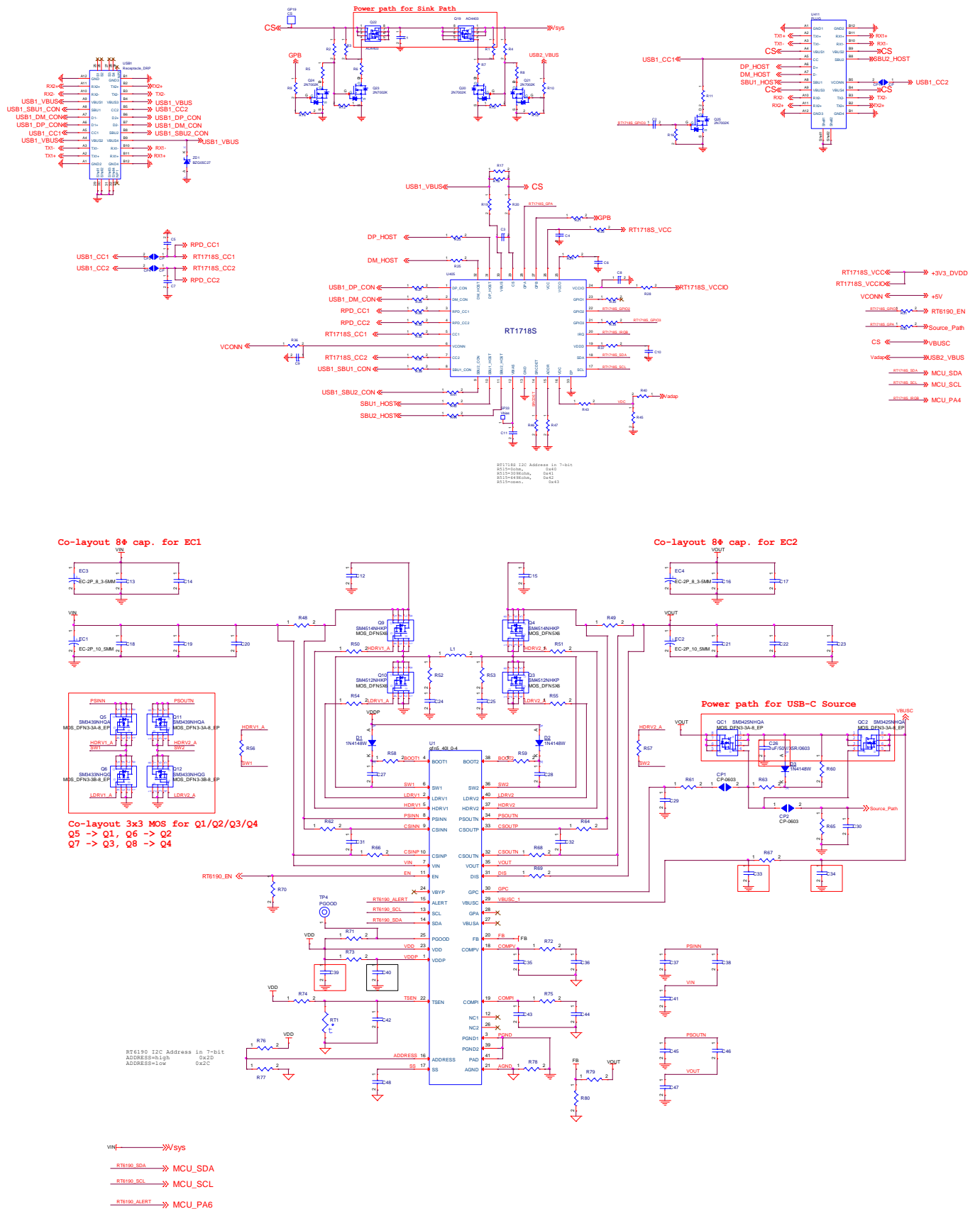

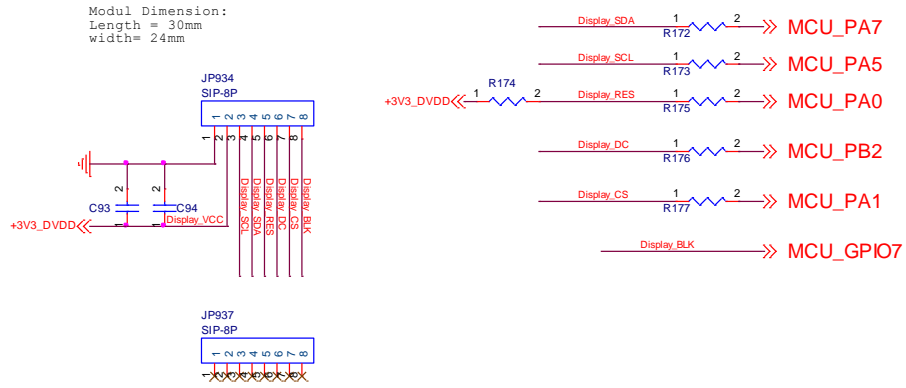

Evaluation Board Layout

Figure 1 to Figure 6 are RT1718SGQW Evaluation Board layout.

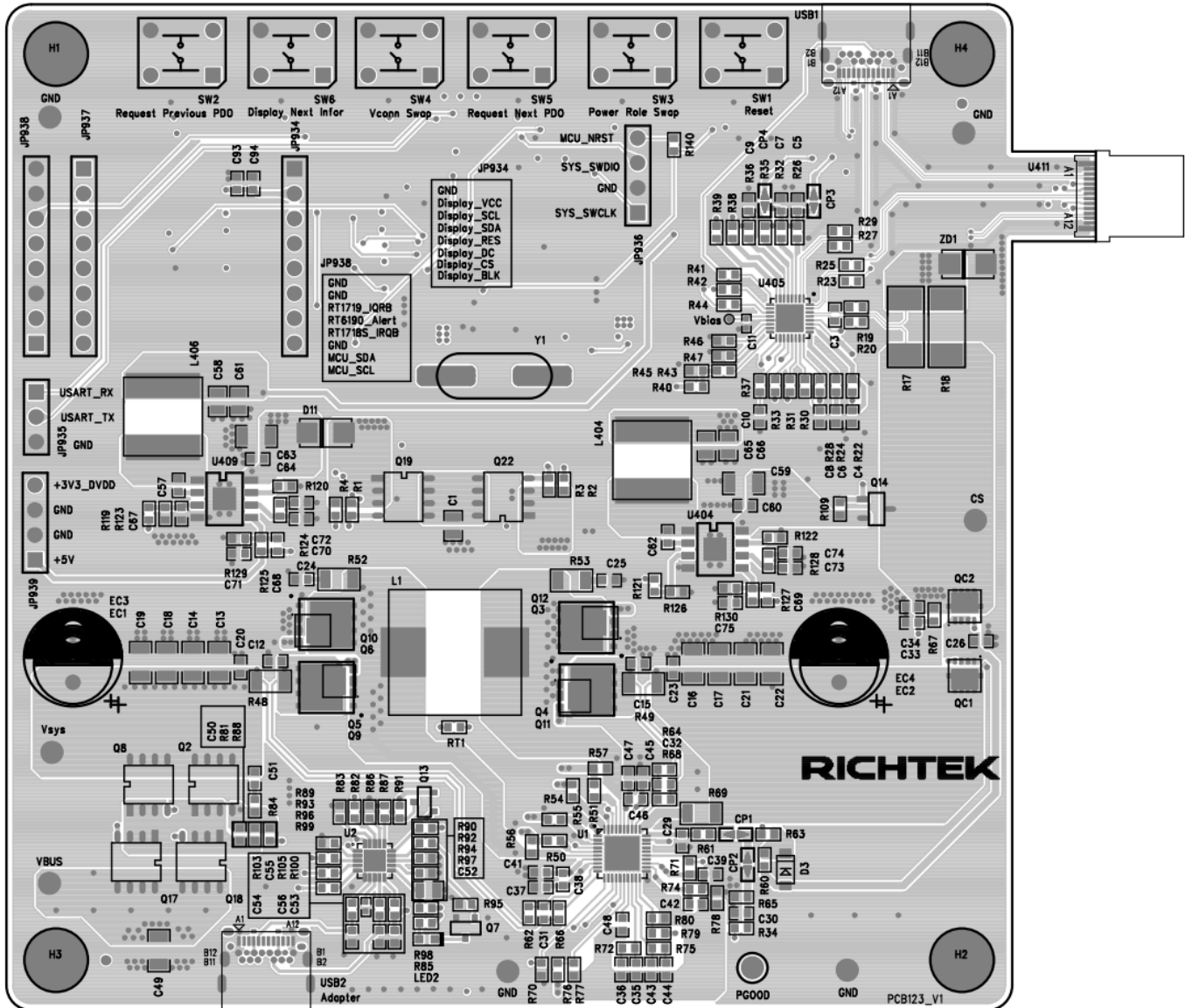

Figure 1. Top View (1st layer)

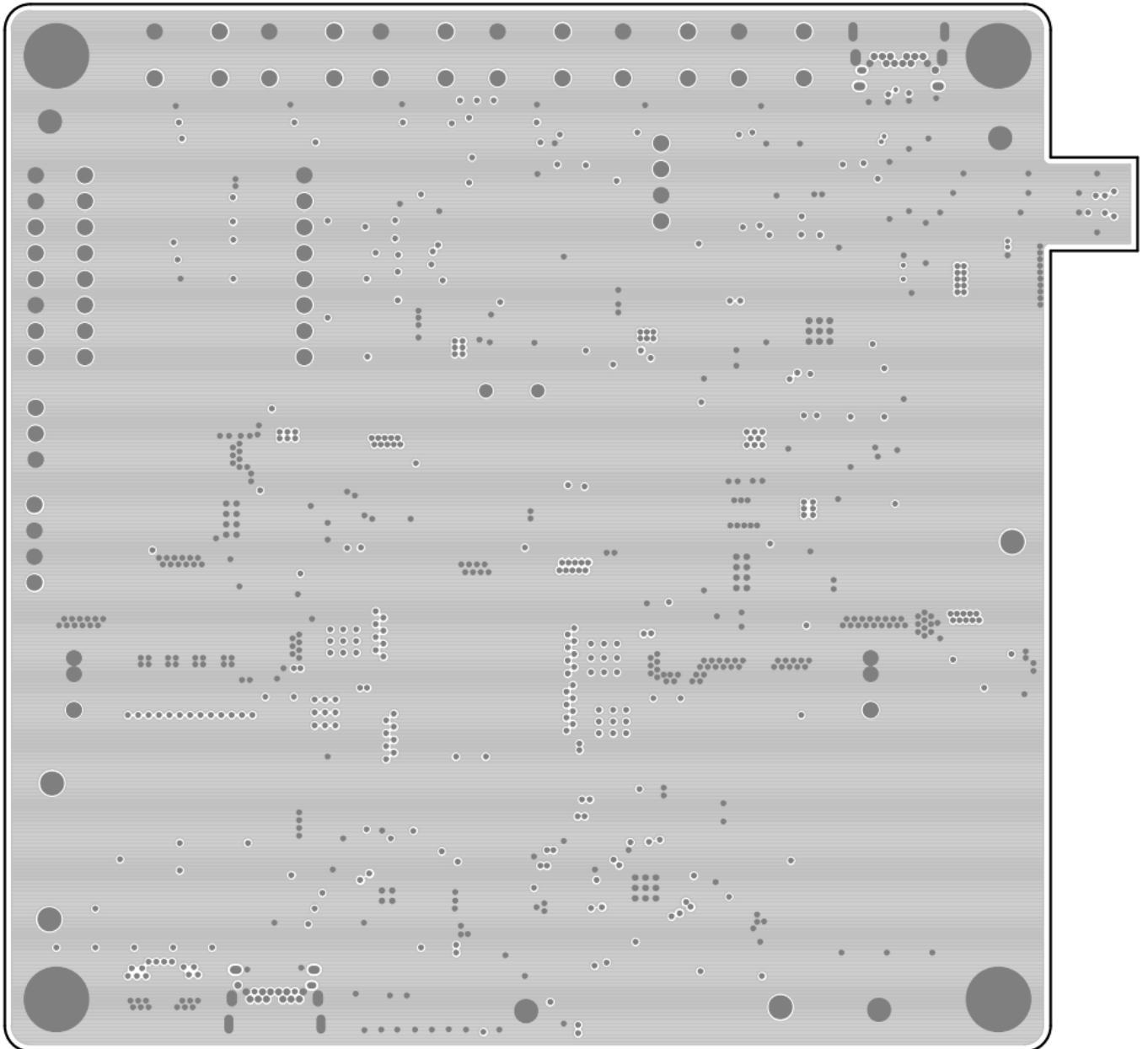

Figure 2. PCB Layout—Inner Side (2nd Layer)

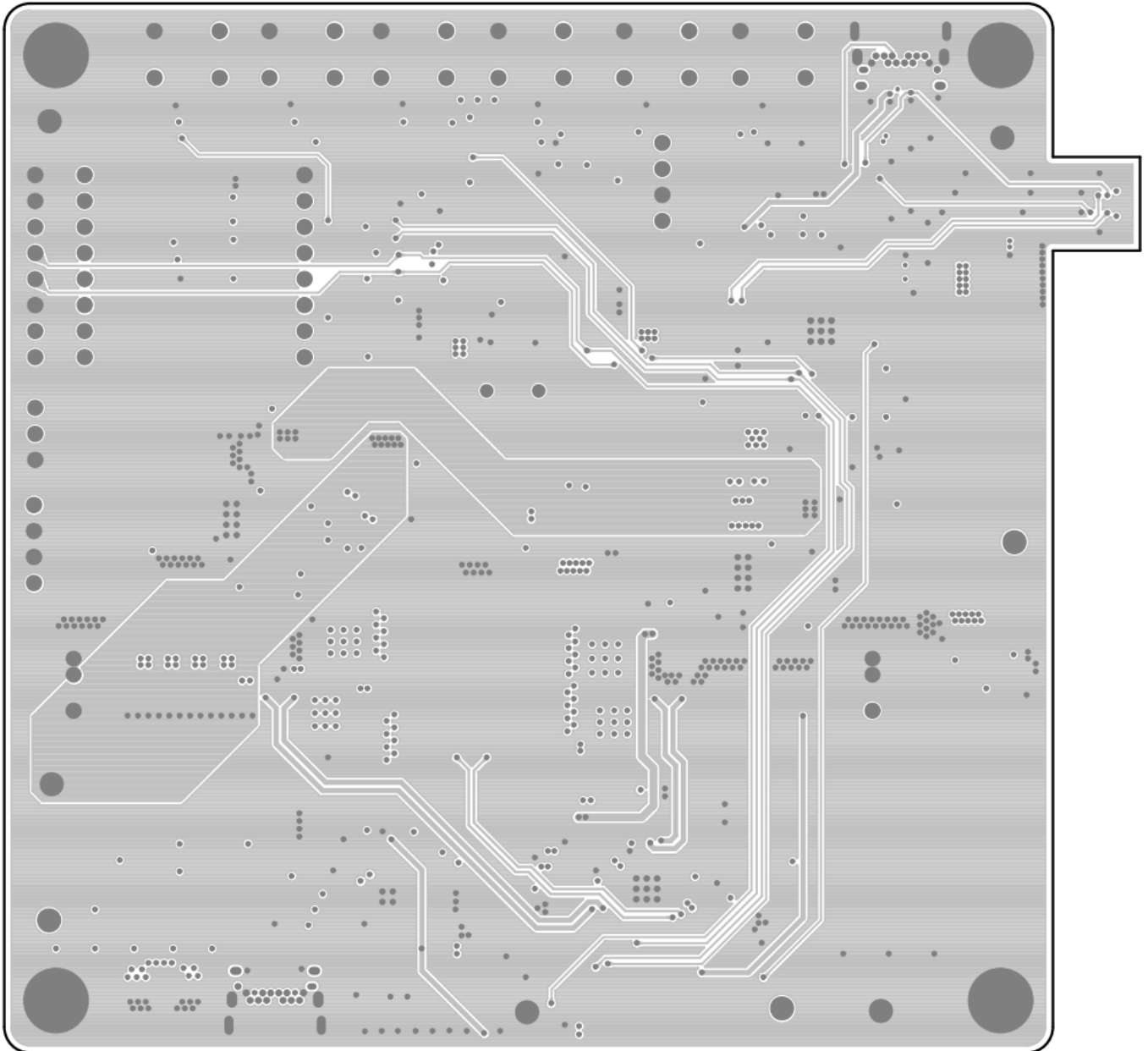

Figure 3. PCB Layout—Inner Side (3rd Layer)

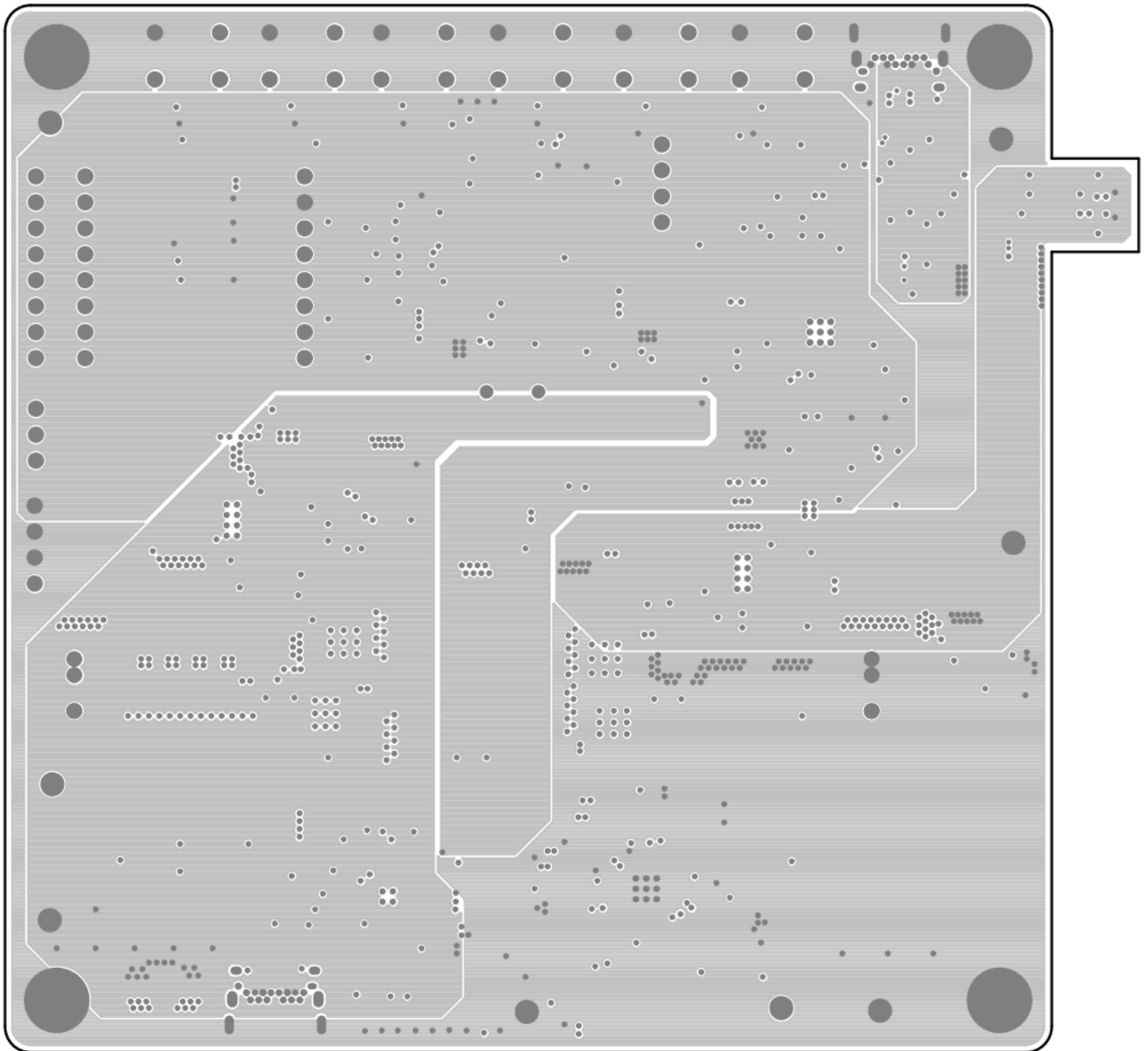

Figure 4. PCB Layout—Inner Side (4th Layer)

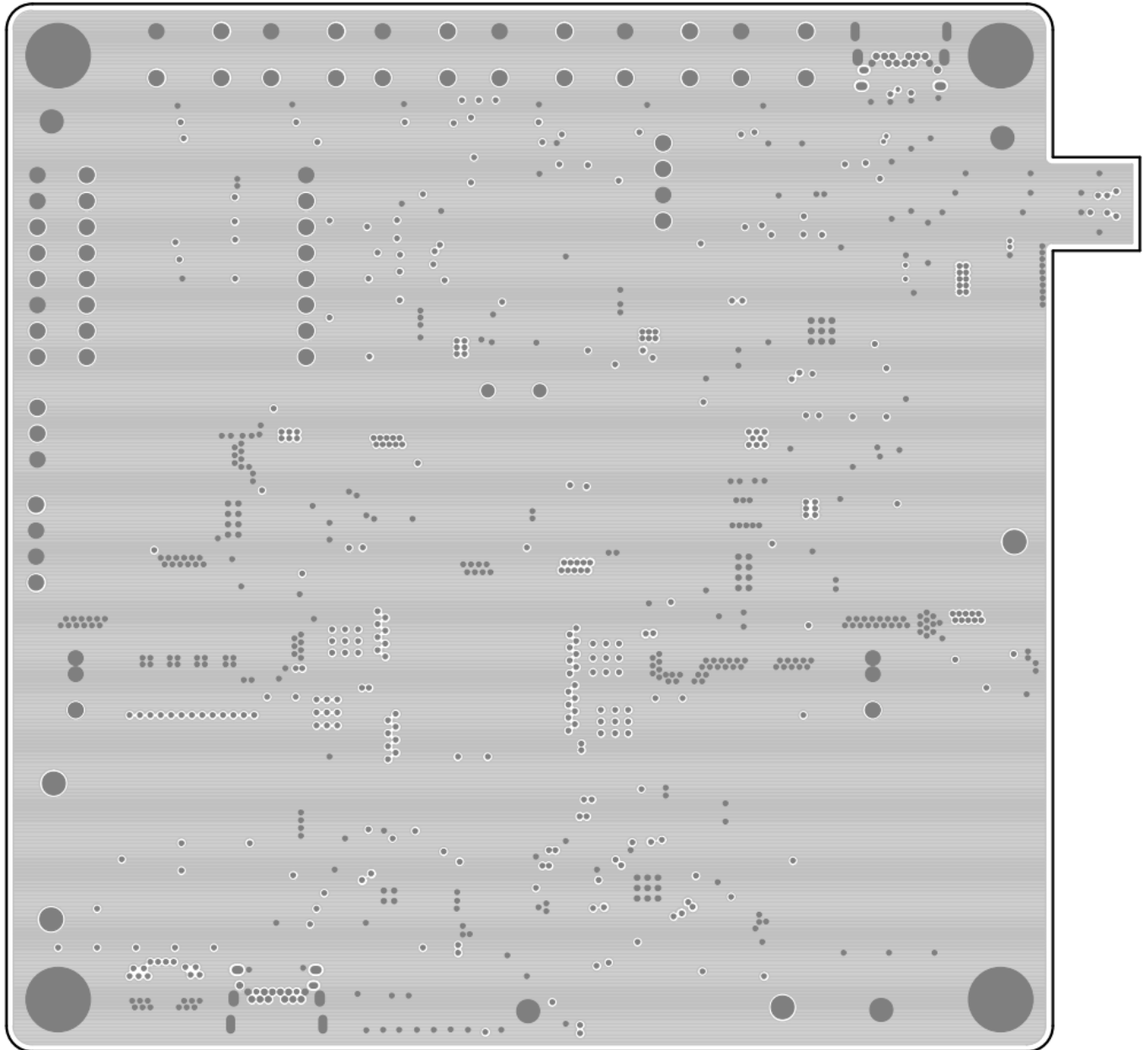

Figure 5. PCB Layout—Inner Side (5th Layer)

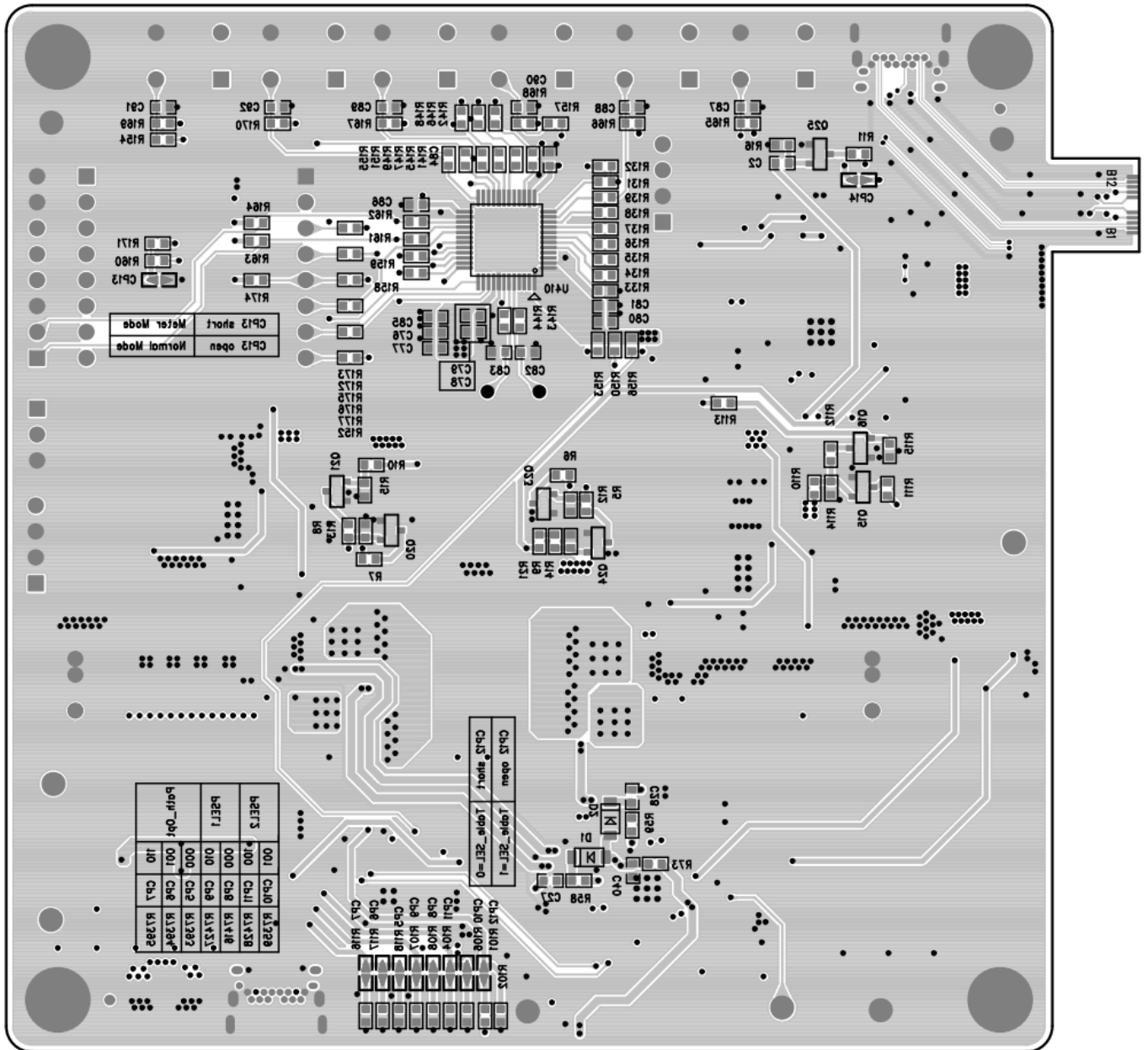

Figure 6. Bottom View (6th Layer)

More Information

For more information, please find the related datasheet or application notes from Richtek website <http://www.richtek.com>.

Important Notice for Richtek Evaluation Board

THIS DOCUMENT IS FOR REFERENCE ONLY, NOTHING CONTAINED IN THIS DOCUMENT SHALL BE CONSTRUED AS RICHTEK'S WARRANTY, EXPRESS OR IMPLIED, UNDER CONTRACT, TORT OR STATUTORY, WITH RESPECT TO THE PRESENTATION HEREIN. IN NO EVENT SHALL RICHTEK BE LIABLE TO BUYER OR USER FOR ANY AND ALL DAMAGES INCLUDING WITHOUT LIMITATION TO DIRECT, INDIRECT, SPECIAL, PUNITIVE OR CONSEQUENTIAL DAMAGES.